

Article number: 51030464000010
Description: Vibration damper GS-M2
100x65x2000-15, NR shore 57

Measures

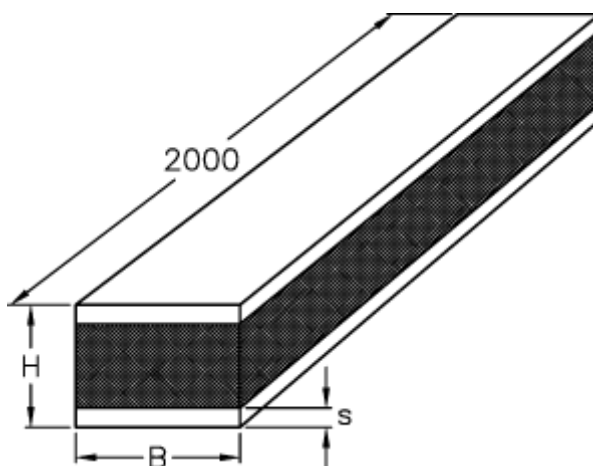

B = 100
H = 65
S = 15